



Installation instructions, accessories

Volvo Car Corporation Gothenburg, Sweden

Instruction No	Version	Part. No.
31338932	1.1	31338929, 31338930, 31338931, 31373494, 31373493, 31373492, 31373462, 31408989, 31373768

Side scuff plate



Installation instructions, accessories

Volvo Car Corporation Gothenburg, Sweden

Materials

Designation	Part number
Isopropanol	1161721

Equipment

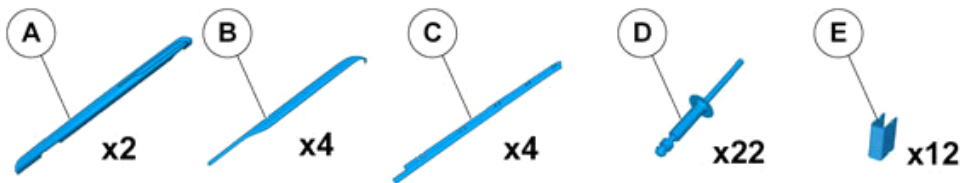
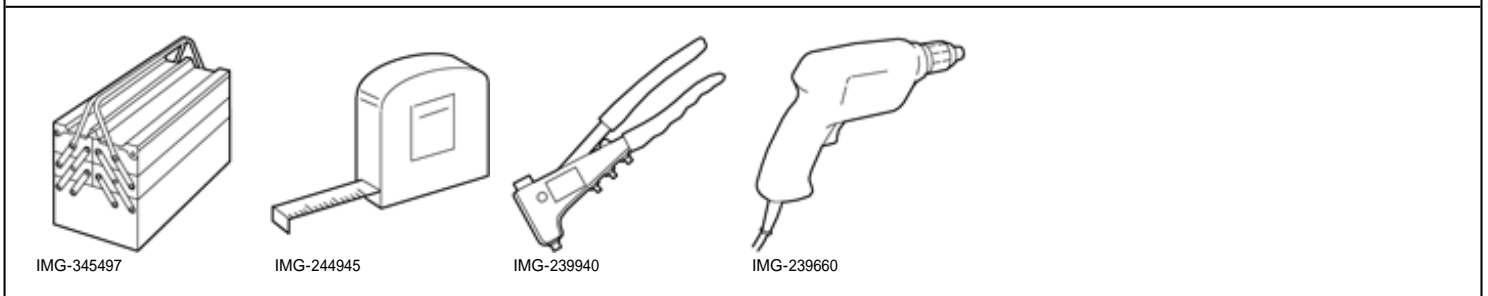

IMG-377501



Installation instructions, accessories

Volvo Car Corporation Gothenburg, Sweden

Information

1

Read through all of the instructions before starting installation.

Notifications and warning texts are for your safety and to minimise the risk of something breaking during installation.

Ensure that all tools stated in the instructions are available before starting installation.

Certain steps in the instructions are only presented in the form of images. Explanatory text is also given for more complicated steps.

In the event of any problems with the instructions or the accessory, contact your local Volvo dealer.

Conditions

2

When installing, the car must retain a temperature of 20 degrees C.

After installation, the car must not be washed for 48 hours

After installation, the car must not be driven for 2 hours

Color symbols

3

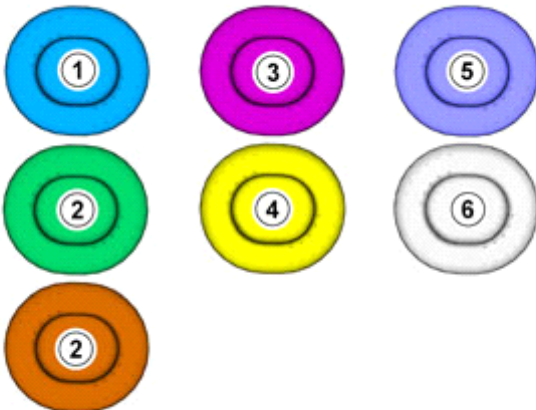

IMG-363036

Note!

This colour chart displays (in colour print and electronic version) the importance of the different colours used in the images of the method steps.

1. Used for focused component, the component with which you will do something.
2. Used as extra colors when you need to show or differentiate additional parts.
3. Used for attachments that are to be removed/installed. May be screws, clips, connectors, etc.
4. Used when the component is not fully removed from the vehicle but only hung to the side.
5. Used for standard tools and special tools.
6. Used as background color for vehicle components.



Installation instructions, accessories

Volvo Car Corporation Gothenburg, Sweden

Applies to unpainted component

4

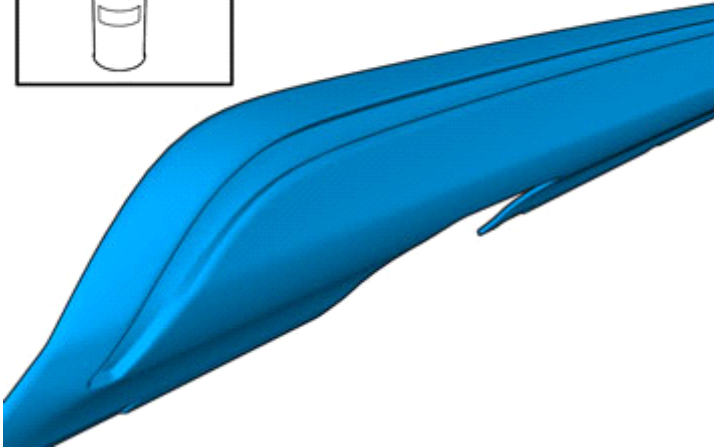

IMG-377438

5

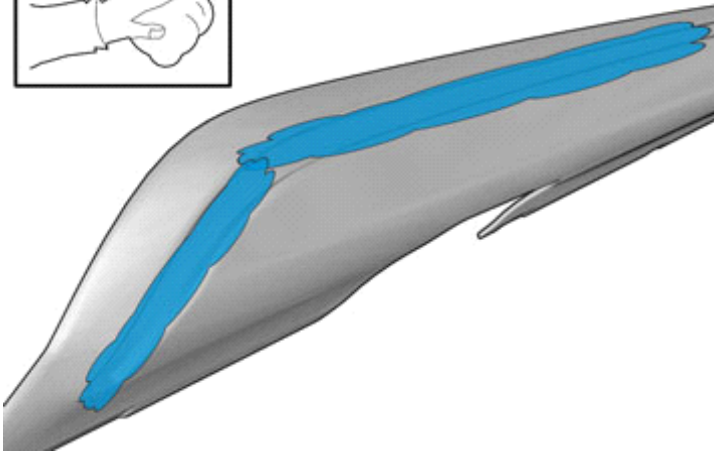

IMG-377442

Caution!

First the paint must dry after painting.

Clean the surface.

Use: 1161721, Isopropanol



Installation instructions, accessories

Volvo Car Corporation Gothenburg, Sweden

6

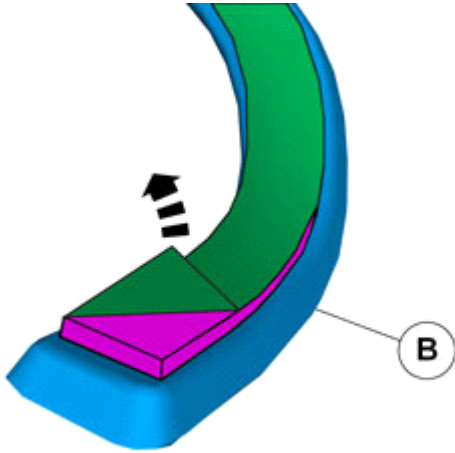

Remove the protective film.

IMG-377445

7

Install component that comes with the accessory kit.

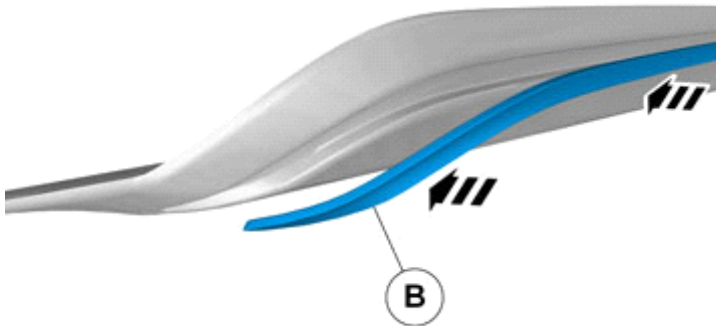

IMG-377446

All vehicles

Accessory installation



Installation instructions, accessories

Volvo Car Corporation Gothenburg, Sweden

8

Clean the surface.

Allow to dry.

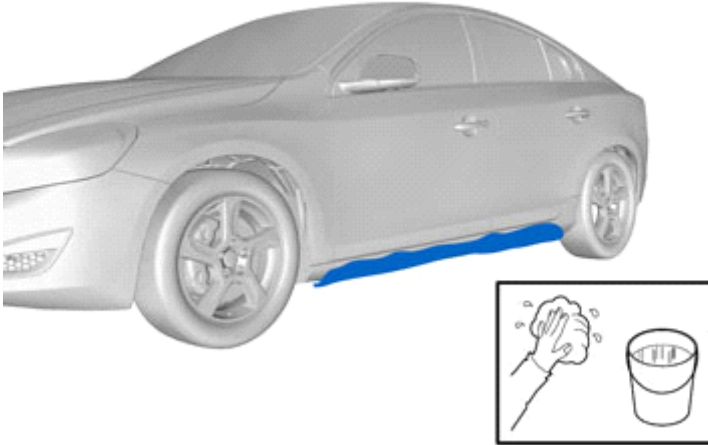

IMG-340411

9

Remove the protective film.

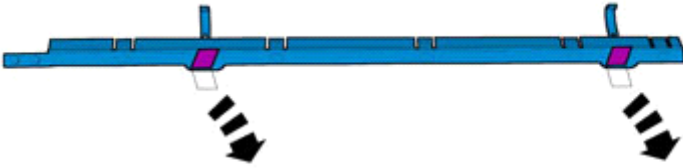

IMG-355879

10

Remove the protective film.

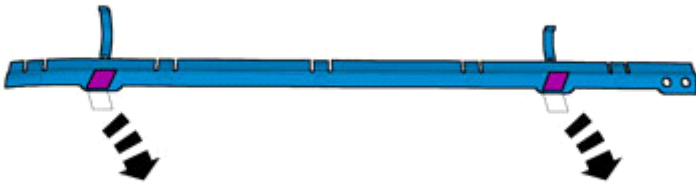

IMG-355880



Installation instructions, accessories

Volvo Car Corporation Gothenburg, Sweden

11

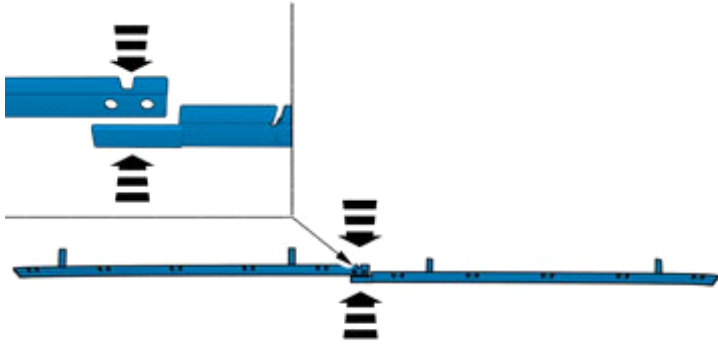

IMG-374598

12

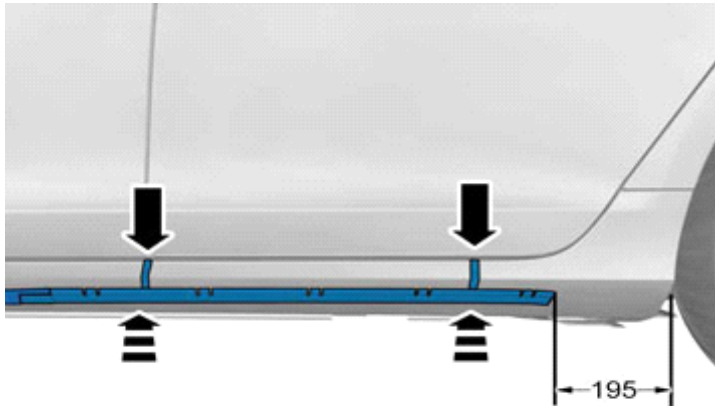

IMG-374452

13

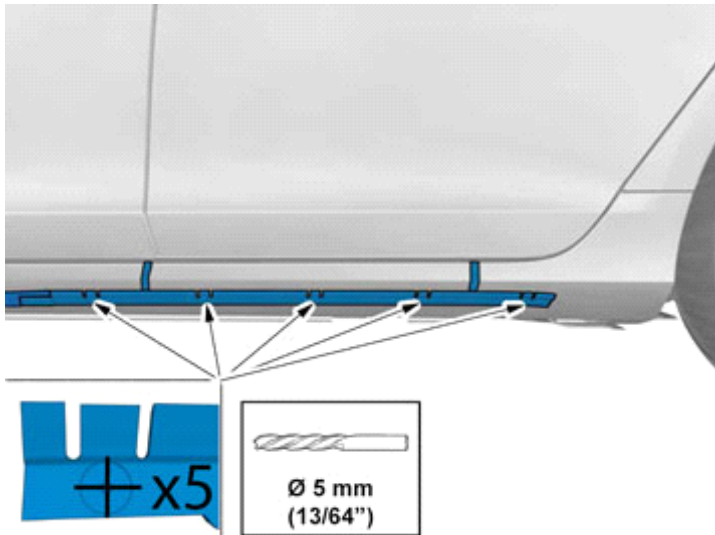

Drill the holes.

IMG-374455



Installation instructions, accessories

Volvo Car Corporation Gothenburg, Sweden

14

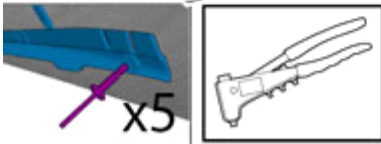
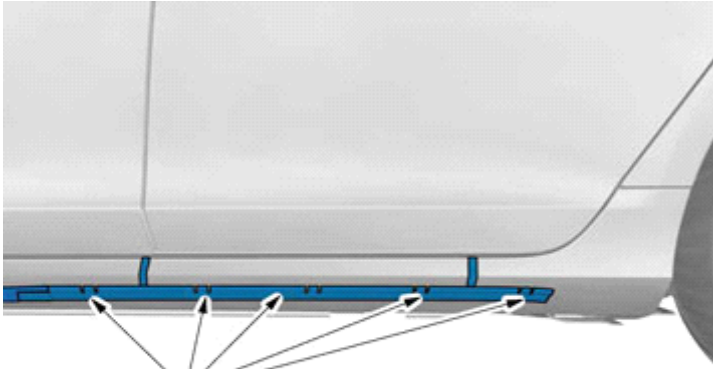

IMG-374453

15

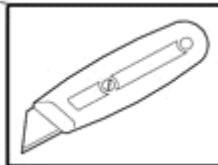
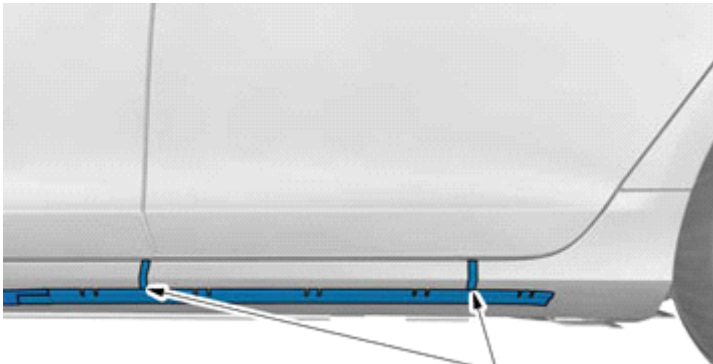

IMG-374454



Installation instructions, accessories

Volvo Car Corporation Gothenburg, Sweden

16

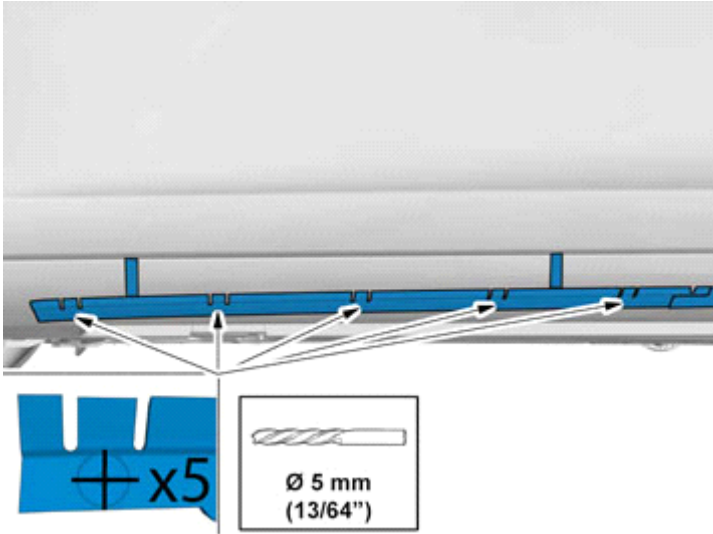

Drill the holes.

IMG-374456

17

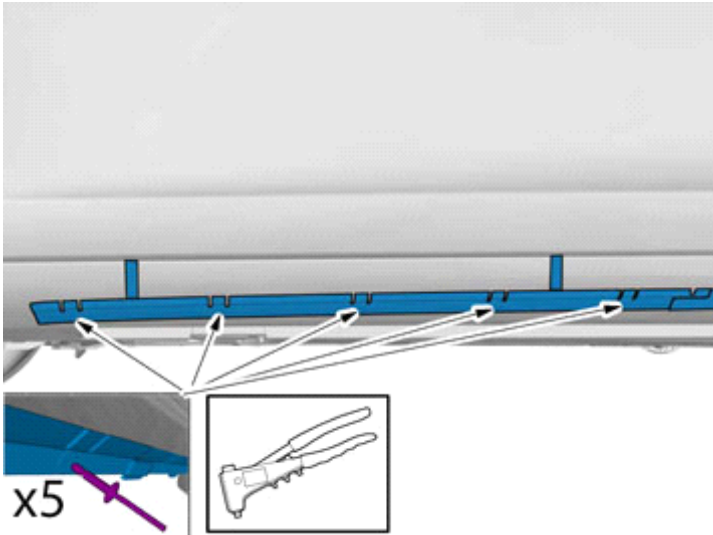

IMG-374459

18

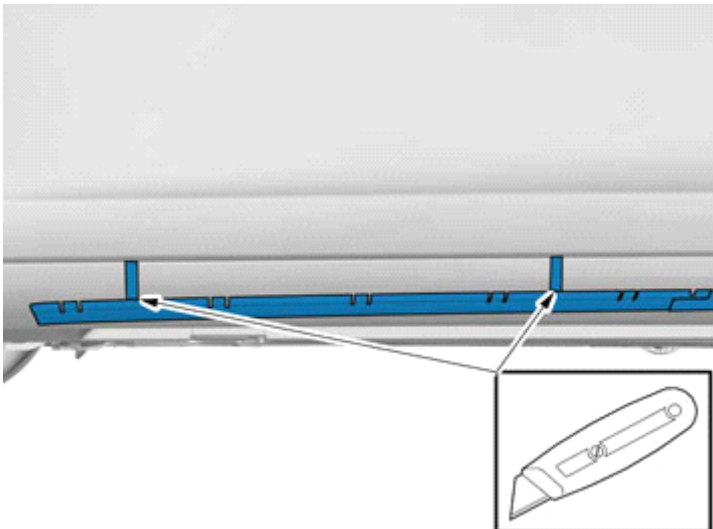

IMG-374457



Installation instructions, accessories

Volvo Car Corporation Gothenburg, Sweden

19

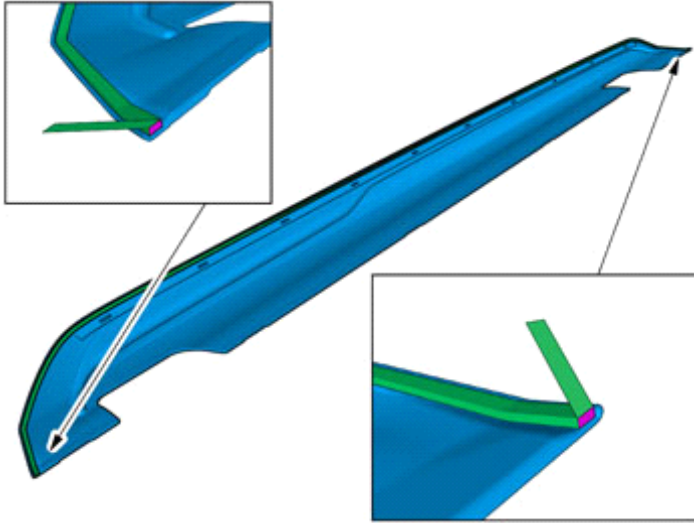

Fold the protective film forward

IMG-376798

20



Clean the surface.

Use: 1161721, Isopropanol

IMG-376972

21

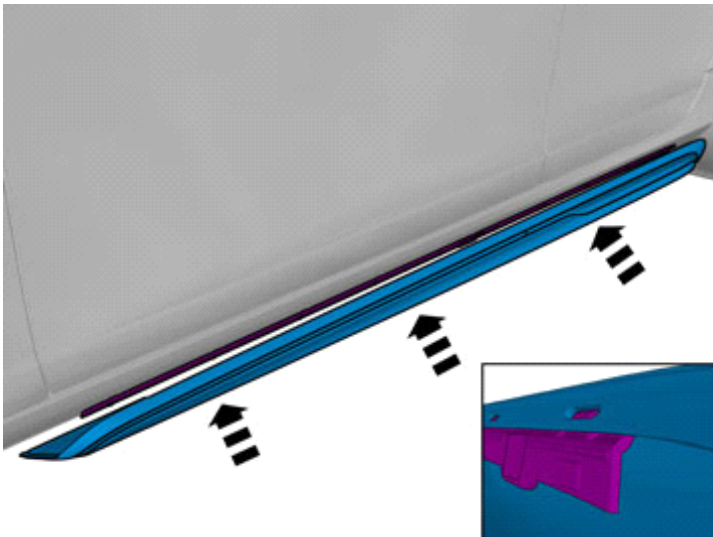

IMG-374471



Installation instructions, accessories

Volvo Car Corporation Gothenburg, Sweden

22

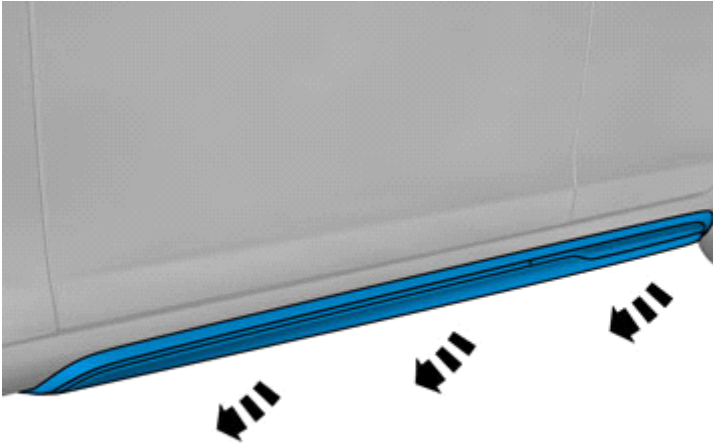

IMG-374473

23

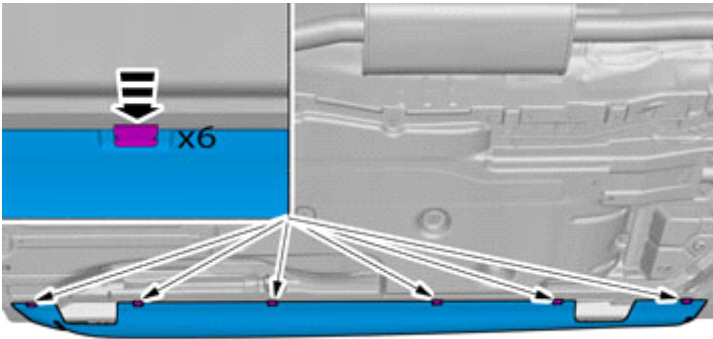

IMG-374476



Installation instructions, accessories

Volvo Car Corporation Gothenburg, Sweden

24

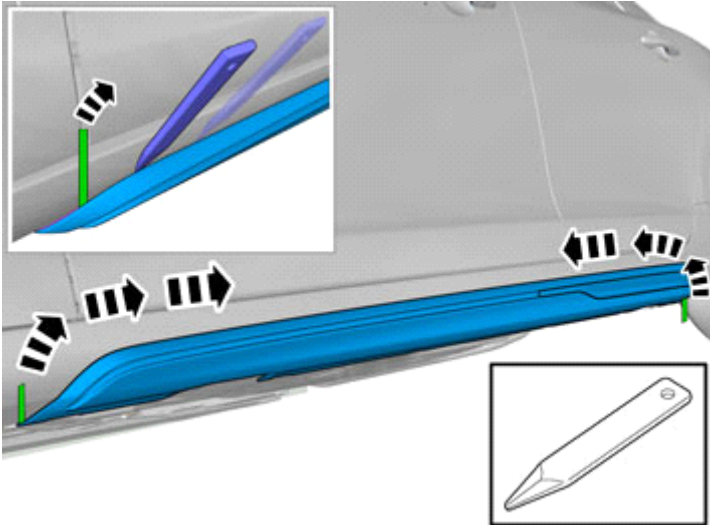

IMG-376811

Caution!

Pull carefully.

Remove the protective film.

Use: Interior trim remover

Hint

Press and apply pressure to the part over the tape for at least 20 seconds.

25

Repeat all method steps for the other side.